

Quik Bridge® Two-Channel Receiver

Document Number: 466-1547 Rev. C
September 1999

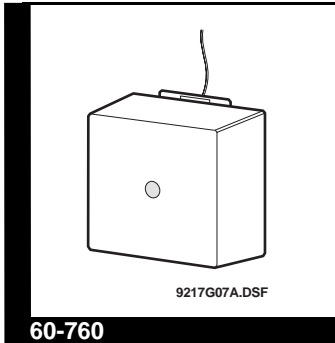

INSTALLATION INSTRUCTIONS

Product Summary

The Quik Bridge® Two-Channel Receiver allows two zones of a hardwired panel to use wireless devices. This allows you to add up to four wireless sensors and /or Keychain Touchpads to the hardwired system. You may assign the wireless devices to the two receiver zones in any combination (4 on zone 1 and 0 on zone 2, 3 on zone 1 and 1 on zone 2, etc.). See the diagrams below for some suggested uses for this receiver. The letters by each Keychain Touchpad represent the button modes (see Table 3) you must enter into the receiver. The receiver recognizes each button mode as a separate device.

- 1) Expanding zones by adding sensors
- 2) Expanding zones, and remote level-sensitive keyswitch arming
- 3) Expanding zones, and controlling one garage door opener

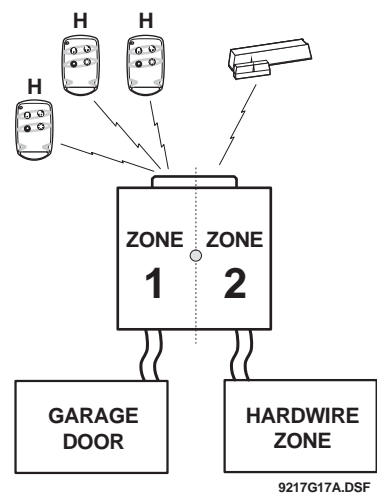
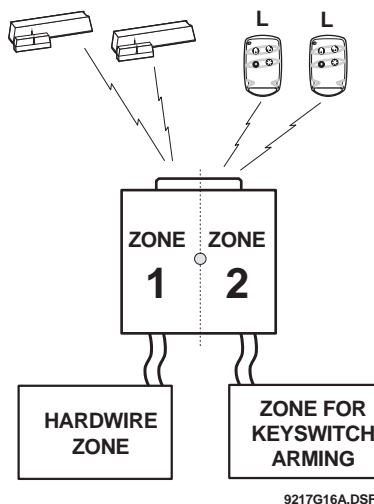
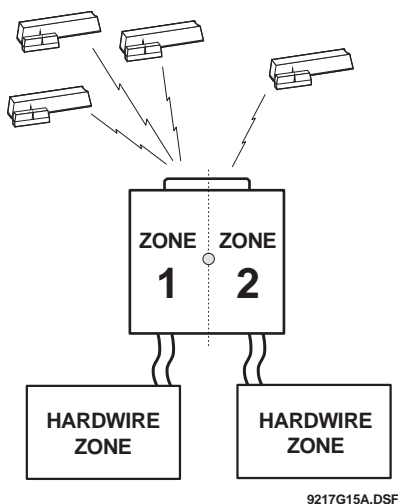

- 4) Controlling one garage door opener, and level-sensitive remote keyswitch arming*

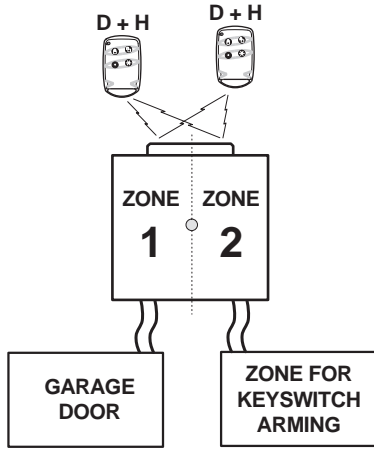

9217G18A.DSF

- 5) Controlling two garage door openers, each using a separate touchpad

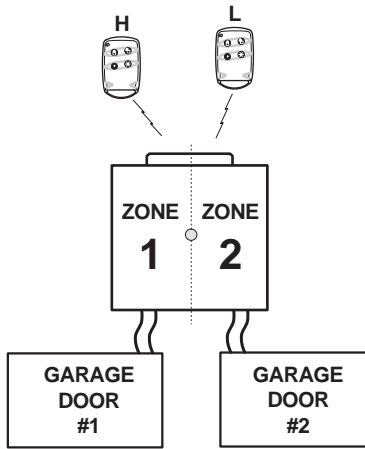

9217G19A.DSF

- 6) Edge-sensitive remote key-switch arming

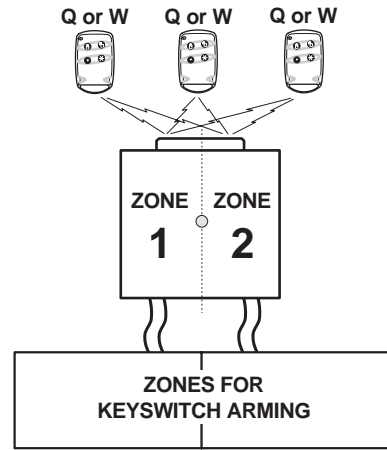

9217G20A.DSF

* In this example, each touchpad counts as two devices, because the receiver recognizes each button mode as a separate device.

- 7) Controlling two garage door openers, each using any touchpad

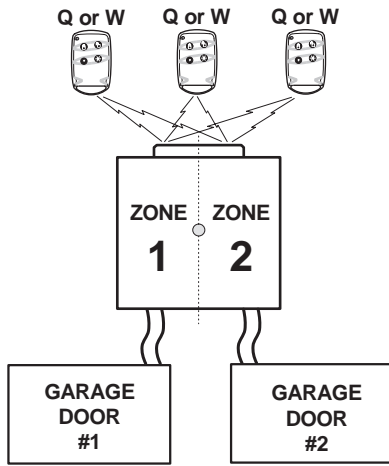

9217G21A.DSF

- 8) Controlling one garage door using any touchpad, while allowing limited access to a second garage door

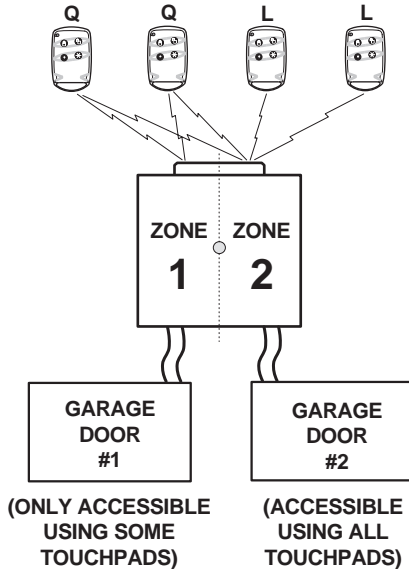

9217G22A.DSF

- 9) Expanding zones, and edge-sensitive keyswitch arming

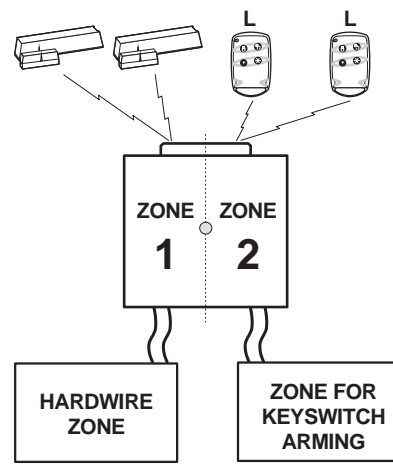

9217G23A.DSF

Sensor and Touchpad Compatibility

The following current ITI Learn Mode™ wireless devices are compatible with this receiver:

- Two- and Four-Button Keychain Touchpads
- PIR motion sensors
- Smoke sensors
- Panic sensors (60-578 only)
- Door/window sensors (see note below)

Note: Only the internal reed switches of a door/window sensor can be used. The receiver does not support the use of door/window sensors with external devices connected to the sensor terminal block.

Control Panel Compatibility

The receiver will work with any conventional hard-wired control panel. To operate efficiently, however, some specific features on some panels may require unique receiver programming. The following procedures will enable you to adapt the receiver to several common control panels. If you have a question or concern about a panel or feature not described here, please call our help line for additional instructions.

Overview of Receiver Operation

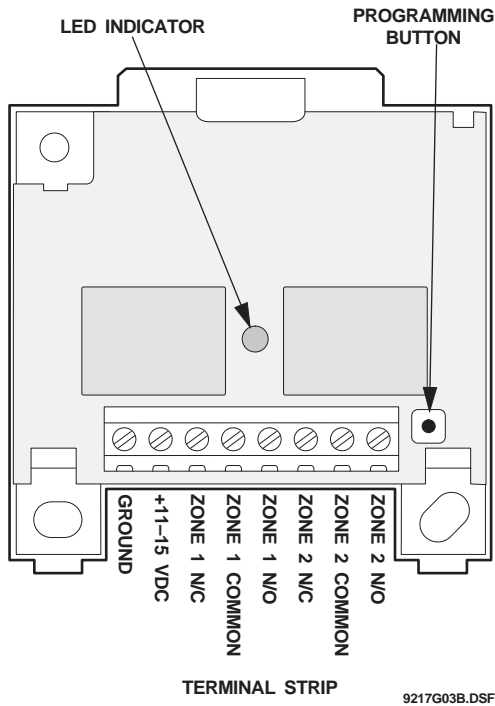

Figure 1. Parts of the Receiver

Programming Button

Use the programming button (see Figure 1) when doing the following procedures:

- Deleting All Wireless Devices (see page 8)
- Adding Wireless Devices (see page 8)

Zone Outputs

The receiver has eight terminals. Terminals 1 and 2 are for power, 3-5 are for wiring zone 1, and 6-8 are for wiring zone 2. Each zone can be configured to be normally closed (N/C) or normally open (N/O) (see “Connecting the Receiver to a Control Panel” on page 10).

LED Indicator

The receiver has one LED. Table 1 lists the possible states of the LED and what they mean.

Table 1. What the states of the LED mean

Power LED	Means
On and flickering irregularly	Receiver has power and is functioning normally.
Off	Receiver has no power.
Flashing regularly	Receiver is ready to learn a wireless device.

Tools and Accessories Needed

Included with Receiver

- Four 1½" screws
- Wall anchors

Not Included with Receiver

- Drill with assorted bits
- EOL resistors (usually supplied with the panel)
- Phillips screwdriver
- Voltmeter
- Wire stripper

Installation Guidelines

Observe the following guidelines when installing the receiver:

- Leave ten inches above the receiver for the antenna.
- Avoid areas that are likely to expose the receiver to moisture.
- Avoid areas with excessive metal or electrical wiring, including furnace and utility rooms.
- Avoid mounting the receiver on a metal surface. When mounting on metal is unavoidable, mount the receiver so that the antenna extends above the metal surface (see Figure e2).

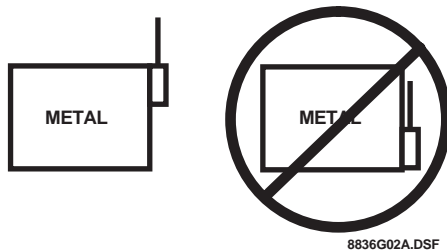

Figure 2. When mounting on metal is unavoidable

Installation

This section explains how to install the Quik Bridge Two-Channel Receiver.

Mounting the Receiver

You can mount the receiver on a sheetrock wall, but you may need to use additional mounting hardware.

CAUTION: You must be free of static electricity before handling circuit boards. Touch a bare metal surface or use a grounding strap to discharge yourself.

To mount the receiver on a wall:

- 1) Choose a location for the receiver.

Note: The Quik Bridge Two-Channel Receiver is a super regenerative receiver. To ensure consistent operation of the receiver, mount it at least three feet away from other super regenerative receivers (such as the receiver in most garage door openers).

- 2) Remove the cover by pressing down on the center of the top edge of the cover (see Figure e3).

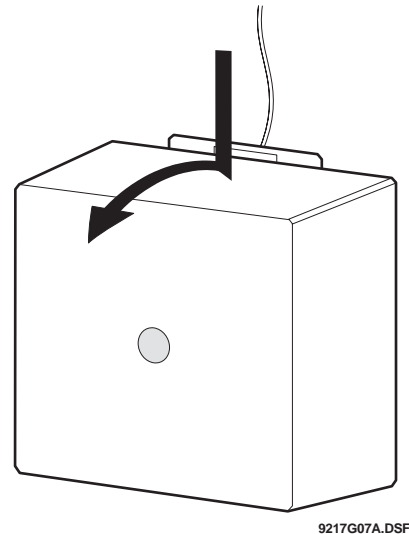
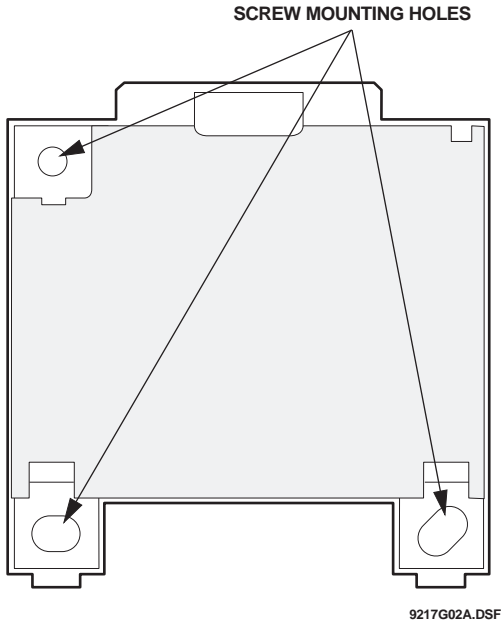

Figure 3. Removing the cover

- 3) Hold the receiver against the wall at the desired height and location, leaving at least ten inches above the base for the antenna. While holding the

receiver against the wall, mark the location of the top-left and lower-right mounting holes.



- 4) Remove the base from the wall and install the appropriate mounting hardware at the two locations you just marked.
- 5) Secure the receiver to the wall using two 1½" Phillips screws (included).
- 6) Secure the antenna to the wall using tape or staples.

Powering the Receiver

CAUTION: You must be free of all static electricity when handling sensors. Touch a grounded metal object before handling the circuit board.

You must connect the receiver to the 11 –15 VDC power outputs on the panel, or to a separate power supply (such as 12-volt DC adapter). To find the DC power terminals on the panel, see the panel installation instructions.

To power the receiver:

- 1) Shut off or remove power from the panel.
- 2) Using Fig e5 as a guide, connect the receiver to the panel or other equivalent power supply.

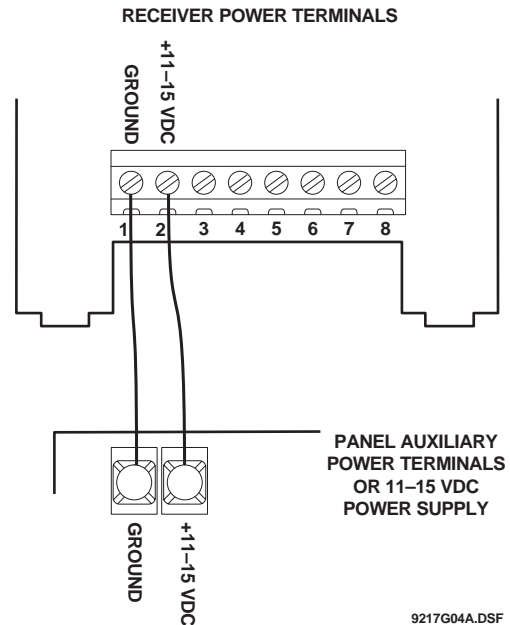

Figure 4. Connecting power to the receiver

Zone Planning

This section explains the capabilities, limitations, and suggested uses of the Quik Bridge Two-Channel Receiver.

Possible Combinations of Wireless Devices

Table 2 shows the combinations of wireless devices that you can program into the receiver. See Table 3 to find out what the Keychain Touchpad buttons do. The receiver can learn a combination of sensors and Keychain Touchpads, but a zone can't be controlled by both a sensor and a Keychain Touchpad. Also, the receiver recognizes each button mode as a separate device.

What the Wireless Devices Can Do

Table 3 explains all the ways to control the system using a Two- or Four-Button Keychain Touchpad, and it lists some suggested uses. Table 4 explains how some common ITI wireless sensors work with the receiver. Use the information from Table 3, Table 4, Table 5, and the panel installation instructions to plan the installation of the wireless devices.

Choosing Momentary or Maintained Switching

Some Keychain Touchpad buttons are used for momentary switching of the zone output when used with the receiver. Other buttons are used for maintained switching. Below is a brief explanation of both types of switching.

- **Momentary** switching is used for controlling most garage door openers. A button that performs momentary switching acts as a push button switch. Pressing the button activates the relay for either 0.5 or 3 seconds, depending upon which button mode is used.
- **Maintained** switching is normally used for arming and disarming the panel or controlling lights with X-10 Lamp Modules. When using buttons that perform maintained switching, the first button acts as an "ON switch," and the second button acts as an "OFF switch." Pressing the first button activates the zone's relay (arms the panel/turns lights on), and pressing the second button deactivates the relay (disarms the panel/turns lights off).

Table 2. Each row shows a possible combination of wireless devices that you can program into the receiver.

Zone 1	Zone 2
sensors	sensors
	sensors
	sensors

* The receiver can learn a total of four devices.

Table 3. Use the information below to plan your installation of Keychain Touchpads (60-606-319.5, 60-607-319.5).

















Button Mode:	To do this...	Add these buttons...	Into this zone.	When finished, this event...	Has this effect...	On this zone...
A	Arm and disarm the system (maintained switching using zone 1)		1	Pressing  Pressing 	Maintained switching	1
D	Arm and disarm the system (maintained switching using zone 2)		2	Pressing  Pressing 	Maintained switching	2
H	Control lights, Control one garage door opener (using zone 1)		1	Pressing 	Momentary switching	1
L	Control lights, Control one garage door opener (using zone 2)		2	Pressing 	Momentary switching	2
Q	Control 2 separate garage door openers (one door per button)		doesn't matter	Pressing 	Momentary switching	1
				Pressing 	Momentary switching	2
W	Control 2 separate garage door openers (one door per button)		doesn't matter	Pressing 	Momentary switching	1
				Pressing 	Momentary switching	2

Table 4. Use the information below to plan your installation of wireless sensors.

This device...	Has this effect on the receiver...	When this event happens...
PIR motion sensors (all ITI models)	Activates the relay for 3 seconds	Sensor is tripped
Smoke sensors (all ITI models)	Activates the relay for 3 seconds	Sensor is tripped
Panic sensors (60-578 only)	Activates the relay for 3 seconds or until the button is released, whichever is last	Sensor is tripped
Door/window sensors	Activates the relay for 3 seconds or until the door is closed, whichever is last	Opening the door
	De-activates the relay	Closing the door

Planning the installation

Before you begin programming, it's a good idea to write down how you plan to use the wireless devices with each zone. Use Table 5 as a worksheet.

Table 5. Zone assignments for wireless devices

Receiver Zone	Panel Zone	Devices/button modes	Functions
1		_____	_____
		_____	_____
		_____	_____
2		_____	_____
		_____	_____
		_____	_____

Programming

This section explains how to add and delete wireless devices from the memory of the Quik Bridge Two-Channel Receiver.

Deleting All Wireless Devices

Delete all wireless devices from the memory of the receiver before you begin adding any new ones. This clears the memory of the receiver and prepares the receiver for new wireless devices.

Note: It is not possible to delete devices one at a time, or to clear only one zone.

To delete all wireless devices from the receiver:

- 1) Press and hold the programming button. In about three seconds, you will hear and feel a “double-click” from the receiver. Continue holding the programming button, and you will hear a second double-click from the receiver (3 seconds). Continue holding the programming button until you hear two more consecutive double-clicks from the receiver (3 seconds).
- 2) Release the programming button.

The memory is cleared, and you can begin adding wireless devices.

Adding Wireless Devices

See Tables 3 and 4 on page 7 for information on compatible ITI wireless devices. If you plan to use an encrypted Keychain Touchpad, see “Transmitting Encryption Codes” before adding this device to the receiver memory.

To add a wireless device to zone 1:

- 1) Press and hold the programming button until you hear and feel a “double-click” from the receiver (about 3 seconds), then release the programming button.
- 2) Wait three seconds. The LED will begin flashing, indicating the receiver is ready to learn a new wireless device.
- 3) Trip the device while holding it at arms length from the receiver:
 - For sensors with tamper switches,* activate the tamper switch by removing the cover
 - For sensors without tamper switches,* put the sensor in alarm.
 - For Keychain Touchpads,* press the desired pair of buttons (see Table 3).
- 4) After about three seconds, the receiver will double-click from one to four times. The number of

double-clicks indicates the number of wireless devices now added to the receiver.

- 5) To add another wireless device into zone 1, go back to step 1 .
- 6) If necessary, complete the installation of the device by adding it to the control panel (see the panel installation instructions).

To add a wireless device to zone 2:

- 1) Press and hold the programming button. In about three seconds you will hear and feel a “double-click” from the receiver. Continue holding the programming button until you hear a second double-click from the receiver (3 seconds), then release the programming button.
- 2) Wait three seconds. The LED will begin flashing, indicating the receiver is ready to learn a new wireless device.
- 3) Trip the device while holding it at arms length from the receiver:
 - For sensors with tamper switches, activate the tamper switch by removing the cover*
 - For sensors without tamper switches, put the sensor in alarm.*
 - For Keychain Touchpads, press the desired pair of buttons (seeTable e3).*
- 4) After about three seconds, the receiver will double-click from one to four times. The number of double-clicks indicates the number of wireless devices now added to the receiver.
- 5) To add another wireless device into zone 2, go back to step 1 .
- 6) If necessary, complete the installation of the device by adding it to the control panel (see the panel installation instructions).

Transmitting Key Codes

Before you can add an encrypted touchpad to a receiver zone, you must use the following procedure to transmit the encrypted key code for that touchpad into the receiver memory.

- 1) Use steps 1-3 of the “Adding Wireless Devices” procedure to prepare the receiver
- 2) Press and release the unlock button twice, then press and hold. The touchpad LED will begin a slow, steady series of flashes. Continue holding until the touchpad LED flashes three times, then release.
- 3) Press and release the unlock button once, then press and hold until the touchpad LED flashes twice, then release.
- 4) Press and hold the unlock button until the touchpad LED flashes once. You will hear a double

click from the receiver, which indicates that the receiver has successfully “learned” the key code.

Using X-10 Devices to Control Light

By using an X-10 Powerflash Interface Module (13-058) and X-10 Lamp Modules (13-204), you can use the Lock and Unlock buttons on a Two- or Four-Button Keychain Touchpad to turn lights on and of .

Setting up Light Control

To set up light control:

- 1) Program button mode A (for zone 1) or D(for zone 2) into the receiver (seeTable e3 for details).
- 2) Set the UNIT CODE and HOUSE CODE dials on the Powerflash Interface Module to match those on the Lamp Module(s).
- 3) Set the Powerflash Interface Module INPUT switch to B and the MODE switch to 3.
- 4) Using Figure 6 as a guide, connect the Powerflash Interface Module to the appropriate receiver zone output.
- 5) Plug in the Powerflash Interface Module and all Lamp Modules.

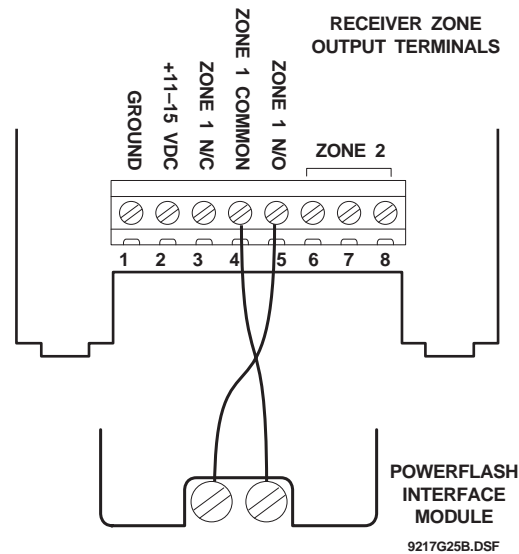

Figure 5. Wiring a receiver zone output to the Powerflash Interface Module

Setting up Garage Door Opener Control

Note: The Quik Bridge Two-Channel Receiver is a super regenerative receiver. To ensure consistent operation of the receiver, mount it at least three feet away from other super regenerative receivers (such as the receiver in most garage door openers).

To set up garage door opener control:

- 1) Program button mode H (for zone 1) or L (for zone 2) into the desired zone of the receiver (see Table 3).
- 2) Using Figure 7 as a guide, connect the garage door opener wires to the appropriate receiver zone output.

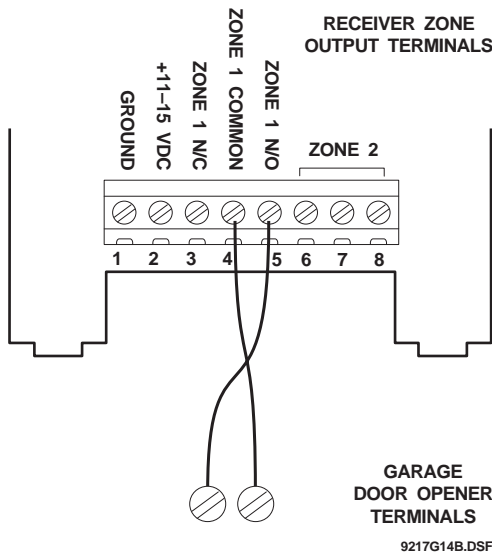

Figure 6. Wiring a receiver zone output to the terminals of a garage door opener

Connecting the Receiver to a Control Panel

Using Figures 7 and 8 as guides, connect the receiver zone output terminals to the panel zone input terminals. Each zone may be configured to be N/C (Normally Closed) or N/O (Normally Open).

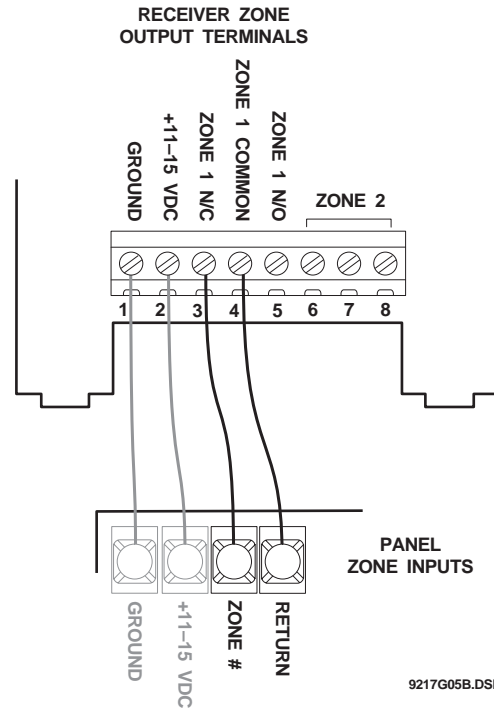

Figure 7. Wiring a receiver zone to be N/C

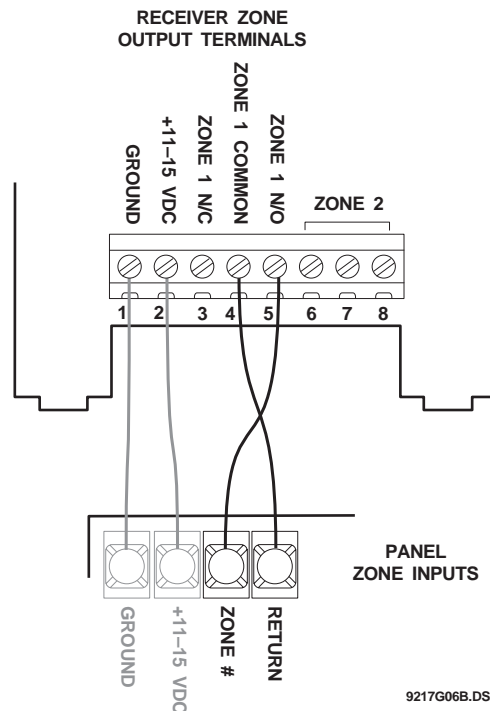

Figure 8. Wiring a receiver zone to be N/O

Testing

This section explains how to test the operation of the wireless devices that you programmed into the Quik Bridge Two-Channel Receiver.

General procedure for testing the Quik Bridge Two-Channel Receiver:

CAUTION: To avoid sending false alarms to the police or fire department when testing monitored systems, always call and notify the central station before activating alarms.

- 1) For monitored systems, call the central station or other monitoring service to let them know you will be testing the system.
- 2) From the panel, exit programming mode.
- 3) Arm the panel.
- 4) Trip a wireless sensor or other device that you added to the receiver.
- 5) Restore the sensor to a non-alarm state, and disarm the system. Repeat steps 4 and 5 for each wireless device.
- 6) Test each button mode on each Keychain Touchpad you added to the receiver.
- 7) If necessary, call the central station and let them know you finished testing the system.

Specifications

Dimensions: 2.5 × 2.6 × 0.9" (64 × 66 × 23 cm)

Maximum current draw (both relays on): 70 m A

Operating temperature range: 40 to 120°F (4 to 49°C)

Power requirements: 11 to 15 VDC

Receiver frequency: 319.5MHz

Receiver range: 250 feet (76 meters) minimum in open air

Receiver type: Super regenerative

Relay contact rating:

Current: 7A maximum

Voltage: 250VAC maximum

Contact: Dry contact Form C

Weight: 2.5 oz., including antenna

Notices



This device complies with FCC Rules Part 15. Operation is subject to the following two conditions:

- 1) This may not cause harmful interference.
- 2) This device must accept any interference that may be received, including interference that may cause undesired operation.

Changes or modifications not expressly approved by Interactive Technologies, Inc. can void the user's authority to operate the equipment.



WIRELESS

Security
Automation
Access Control

INTERACTIVE TECHNOLOGIES, INC.

2266 SECOND STREET NORTH
NORTH SAINT PAUL, MN 55109

T: 651/777-2690

F: 651/779-4890

ITI is a registered trademark of Interactive Technologies, Inc. Quik Bridge is a trademark of Interactive Technologies, Inc.

